



inRAX[®]

Product Catalog

ProSoft[®]
TECHNOLOGY

inRAx® Product Line

The inRAx® product line provides in-chassis protocol interface modules, flow computers, open solution modules, FLEX adapters and drive adapters for Allen-Bradley platforms. The inRAx family of products allows Allen-Bradley platforms to communicate with dissimilar networks and protocols. Platforms supported include:



ControlLogix™



SLC™



PLC-5™



CompactLogix™



FLEX I/O and
FLEXLogix™



SCANport™

inRAx®

Allen-Bradley, CompactLogix, ControlLogix, FLEXLogix, PLC-5 and SCANport are registered trademarks of Rockwell Automation, Inc.

Product Index

ASCII Connectivity	4
Bardac drive.web Connectivity	18
BASIC Programmable Module	12
Bosch Interface for Robert Bosch Packaging Machinery	16
Bristol Babcock Serial Slave Connectivity	19
'C' Programmable Modules	12
Command Language Master Connectivity for SICK Barcode	17
DF1 Connectivity	5
DH-485 Connectivity	4
DNP 3.0 Connectivity	5
DNP 3.0 over Ethernet Connectivity	7
Drives/SCANport Adapters	8
Emerson FX Drives Connectivity	18
EtherNet/IP Connectivity for SLC and PLC-5	6
FA Control Network Connectivity	19
Fisher ROC Connectivity	19
FLEX I/O Adapters	8
Foxboro/Systronics Minimize RTU Slave Connectivity	19
Generic Ethernet Connectivity	7
Harris 5000/5500/6000 RTU Slave Connectivity	17
HART Multi-drop Connectivity	14
High-Speed Wireless Connectivity	15
High-Speed Wireless EtherNet/IP Server for ControlLogix	6
Honeywell 7800 Series Master Connectivity	17
Honeywell DE Connectivity	14
IEC 60870-5-101 Connectivity	5
IEC 60870-5-103 Master Connectivity	5
IEC 60870-5-104 Server Connectivity	7
In-Rack Flow Computer	14
In-Rack PC for ControlLogix	9
In-Rack PC with Data Historian	9
In-Rack PC with OPC Server	9
inRAx® Products Chart	10
Johnson Control Metasys N2 Slave Connectivity	16
Landis & Gyr Telegyr 8979F Connectivity	17
Limitorque Master Connectivity	19
MDA Scientific (Honeywell/Zellweger) Gas Analyzer Module	18
MetOne PCX Water Master Connectivity	17
Modbus Connectivity	4
Modbus Plus Connectivity	13
Modbus TCP/IP Connectivity	6
MTS Level Plus Interface Module	17
PROFIBUS DP Slave	13
PROFIBUS DPV1 Master for ControlLogix	13
ProSoft Tested Program	15
Siemens 3964R Connectivity	17
Siemens SEABus Master Connectivity	16
Teledyne CA Slave Communication Module	18
YORK Chiller Master Connectivity	16

Global Distribution

We think like you do

ProSoft Technology® products are distributed and supported worldwide through a network of over 500 distributors in over 50 countries. Our knowledgeable distributors are familiar with your application needs. For a complete list of distributors, go to our website at www.prosoft-technology.com.

Global Support

We are there for you

All ProSoft Technology products are backed with free, unlimited technical support. Contact our worldwide Technical Support team directly by phone or email. For contact information in your region see page 20.

Global Offices

We are where you are

ProSoft Technology has regional offices worldwide available to help you with all your industrial application needs. If you need help choosing a ProSoft Technology solution for your particular application, check out our contact information under distributor sales on the website at www.prosoft-technology.com. Whether your application is large or small, our technical professionals are there to help you choose the right communication solution.



Serial Protocol Communication Solutions

Application Story

Water Flows in Iraq

In Badaah, Iraq, David Watts adds finishing touches to his work in the Nasiriyah Water Treatment Plant, his home away from home for nearly eight weeks. The largest water treatment facility in Southern Iraq, the Nasiriyah Plant supplies 10,000 cubic meters per hour of fresh drinking water to approximately three million Iraqis.

When Watts arrived in Iraq, he discovered Allen-Bradley PLCs to be limited in their programming with only 10 percent completed. The Modicon Quantum PLC was roughly 80 percent ready.

"The GUI was also limited and static in its appearance and function," Watts said. Individual ControlLogix processors were placed at the three pump stations along the Garaaf River. The fourth ControlLogix was placed in the control room to function as a SCADA host for the plant. The Quantum PLC, which has 20 Remote I/O drops, was used to control the backwash of 20 individual filter cells.

"Then came the problem of getting the Quantum PLC to communicate with the ControlLogix," said Watts. "I had never used a ProSoft Technology® interface module before. And, of course there were no manuals or cables on location to help me with this, so I called ProSoft Tech Support."

ProSoft Technical Support Engineer Scott Lee answered the call. "You could tell right away that he had his hands full," said Lee. "But he obviously knew how to program and only needed a little nudge in the right direction to get the ProSoft Modbus Interface up and running."

The Plant takes water from the Garaaf River and delivers it into 10 large clarifiers to allow the sediments to settle. Alum is then mixed with the water to allow any remaining particles to coagulate prior to sending the water to the flocculators. Next, the partially cleaned water is sent to sand filters where a majority of the bacteria is removed. Finally, chlorine is added to kill any remaining bacteria and the water is sent to 2 underground storage tanks. The new plant went online in early 2007. "This new water facility rivals any state of the art water treatment plant we have in the States," said Watts.

Modbus Connectivity

- RTU and ASCII modes
- Independently configured ports operating as Master and/or Slave
- Continuous polling of Command List
- Ideal for SCADA and Modbus device interfaces (transmitters, drives, flow meters)

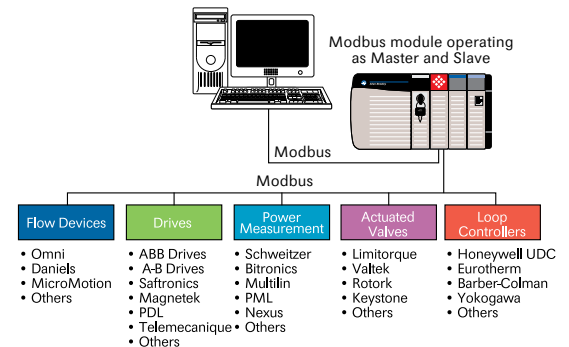

Example Application: User requires Modbus connection from an Allen-Bradley platform to Modbus-compatible devices or SCADA systems.

- Solution:**
- MVI56-MCM** for ControlLogix™
 - MVI56-MCMR** for ControlLogix remote chassis
 - MVI46-MCM** for SLC™ 500
 - MVI71-MCM** for PLC-5™
 - MVI94-MCM** for FLEX I/O and FLEXLogix™
 - MVI69-MCM** for CompactLogix™
 - 3100-MCM** for PLC
 - 3150-MCM** for SLC

ASCII Connectivity

- Connect to serial devices
- Ladder programmed and configured
- 2 serial ports (1 port on FLEX)
- Read/Write ASCII data
- Built-in data analyzer
- Supports RS-232/422/485 connections

Example Application: User requires connectivity to serial (ASCII) RS-232, 422, 485 type devices: barcode scanners, weigh scales, text displays, RFID tags, etc.

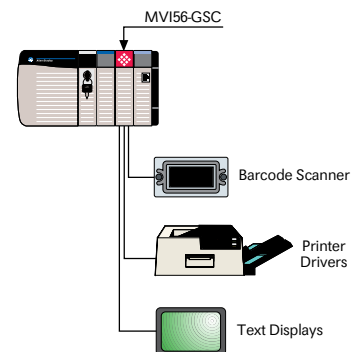

- Solution:**
- MVI56-GSC** for ControlLogix
 - MVI46-GSC** for SLC 500
 - MVI71-GSC** for PLC-5
 - MVI94-GSC-E** for FlexLogix/FLEX I/O
 - MVI69-GSC** for CompactLogix

DH-485 Connectivity

- Connect to SLC 500 processors
- Read/Write Data
- Single-slot module
- Ideal for existing applications

Example Application: User requires addition of DH-485 connectivity to ControlLogix providing connectivity to an SLC on DH-485.

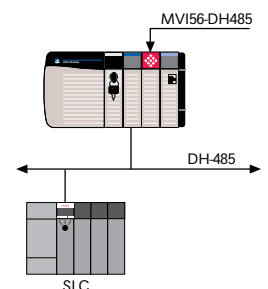

- Solution:**
- MVI56-DH485** for ControlLogix
 - MVI69-DH485** for CompactLogix

DF1 Connectivity

- Connectivity to DF1-supported field devices
- DF1 Half (Master-Slave) and Full duplex protocols (Master-Slave)
- Ideal for SCADA and DF1 device interfaces

Example Application: User requires additional DF1 ports for ControlLogix™, CompactLogix™, PLC, SLC, and FLEXLogix platforms.

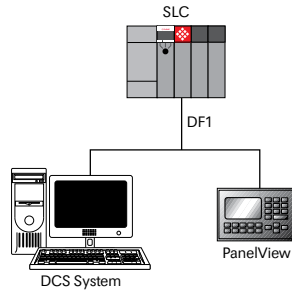

- Solution:**
- MVI56-DFCM** for ControlLogix
 - MVI56-DFCMR** for ControlLogix remote chassis
 - MVI46-DFCM** for SLC™ 500
 - MVI71-DFCM** for PLC-5™
 - MVI94-DFCM** for FLEXLogix™
 - MVI69-DFCM** for CompactLogix

IEC 60870-5-103 Master Connectivity

Example Application: User requires connectivity from an Allen-Bradley platform to IEC 60870-5-103 protection devices.

- Solution:**
- MVI56-103M** for ControlLogix
 - MVI56-103MR** (Remote Chassis) for ControlLogix
 - MVI46-103M** for SLC 500
 - MVI69-103M** for CompactLogix
 - MVI71-103M** for PLC-5

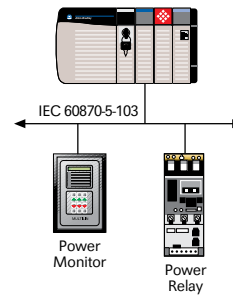

IEC 60870-5-101 Connectivity

- Connectivity to widespread telecontrol systems such as electricity distribution SCADA

Example Application: User requires connectivity from an Allen-Bradley platform to an IEC 60870-5-101 compatible device or SCADA system.

- Solution:**
- MVI56-101S (Slave)** for ControlLogix
 - MVI56-101M (Master)** for ControlLogix
 - MVI46-101S (Slave)** for SLC 500
 - MVI46-101M (Master)** for SLC 500
 - MVI69-101S (Slave)** for CompactLogix
 - MVI69-101M (Master)** for CompactLogix
 - MVI71-101S (Slave)** for PLC-5
 - MVI71-101M (Master)** for PLC 5

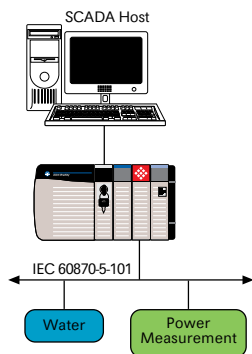

DNP 3.0 Connectivity

- Time stamping and Report-by-Exception
- Conditional and continuous polling of command list
- Supports full Level 2 minimum command sets
- Ideal for substation automation, water/wastewater, and SCADA applications

Example Application: User requires DNP 3.0 connectivity from an Allen-Bradley platform to DNP 3.0-compatible device.

- Solution:**
- MVI56-DNP** for ControlLogix
 - MVI46-DNP** for SLC 500
 - MVI71-DNP** for PLC-5
 - MVI94-DNP** for FLEX I/O and FLEXLogix
 - MVI69-DNP** for CompactLogix

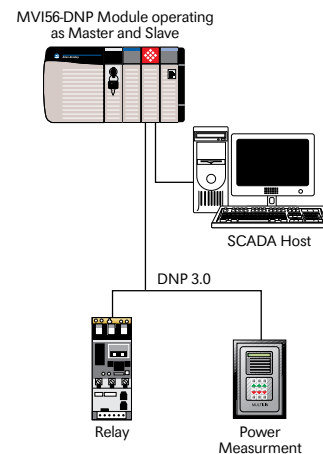

Application Story



Wastewater Treatment Made Easy with Modbus

Elian Jessen of HV-Turbo in Denmark recently delivered and installed compressors for the Jerusalem Wastewater Treatment Plant. The existing plant network was Genius-bus. In order to send and receive information between SCADA and the HV-Turbo main panel, a GE-Fanuc 90-30 PLC was installed in the HV-Turbo main next to the already installed Allen-Bradley SLC. Both the A-B SLC and the GE PLC needed to communicate via Modbus. "The customer called me and said they had to communicate with Modbus and was that possible to do with an Allen-Bradley SLC 500?" said Elian Jessen of HV-Turbo. "I knew about ProSoft Technology® so I told him 'Yes, no problem.' ProSoft Technology kindly forwarded to us a manual on the module so that HV-Turbo could see it was not that complicated to set up the communication."

ProSoft Technology's 3150-MCM module was chosen to be the master for the communication, transferring vital data between SCADA and the main PLC via the GE-Fanuc controller.

"Since this project was completed, we have ordered 25 similar modules for connecting some of our other specially designed control panels to our customer's main panels in six refinery plants in India with great success using our own multipurpose software for the MCM," said Jessen.

Modbus TCP/IP Connectivity

- 4000 word module memory usage completely user-definable
- 10/100 Mbps Ethernet compatible interface
- Backplane compatible, resides in any slot

Example Application: User requires connectivity from ControlLogix™, PLCs, or SLCs directly to Modbus TCP/IP network.

Solution: **MVI56-MNET** for ControlLogix
MVI56-MNETC for ControlLogix, Client Only
MVI46-MNET for SLC™ 500
MVI46-MNETC for SLC 500 client only
MVI69-MNET for CompactLogix™
MVI71-MNET for PLC-5™

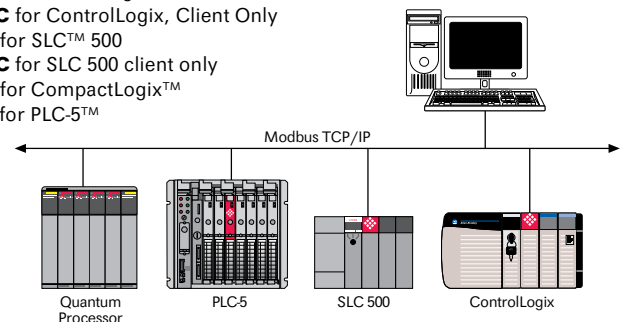

EtherNet/IP Connectivity for SLC and PLC-5®

- Supports PLC-5 family, SLC 5/02,03, 04, & 05
- Resides in any local slot (SLC and/or remote rack PLC-5)
- Backplane data transfer
- Client/Server - Read/Write Data
- 10/100 Mbps
- Program Over Ethernet via Serial CH0 Connection

Example Application: User requires addition of EtherNet/IP connectivity to SLC and/or PLC. Installations where application requires having both EtherNet/IP and DH+™ or DH-485. For SLC 5/05 or PLC-5-E users, add additional Ethernet connectivity.

Solution: **MVI46-DFNT** for SLC 500
MVI69-DFNT for CompactLogix
MVI71-DFNT for PLC-5

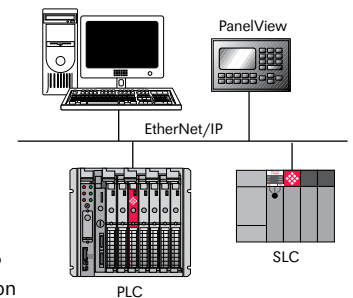

High-Speed Wireless EtherNet/IP Server for ControlLogix

- High-speed Wi-Fi wireless connectivity
- Links wireless laptops, PDAs and workstations for PLC programming and HMI
- Wireless range up to 1000 feet (330 m); may be extended with access points and repeaters
- Wireless connectivity to other networks (Bridging)
 - Wirelessly configure ControlNet, Ethernet and DeviceNet
 - Supports RSLogix 5000®, RSView®, RSLinx® and RSNetworkx®

Example Application: User requires wireless programming and/or HMI application, arc flash safety procedures or separation from the wired plant or business network.

Solution: **MVI56-WA-EIP**

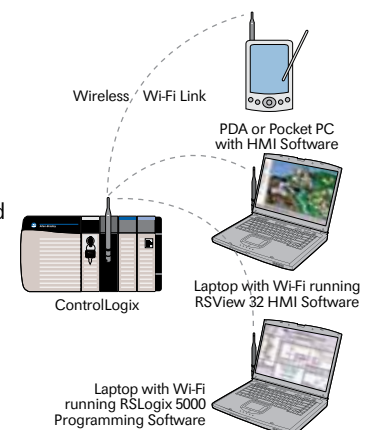

IEC 60870-5-104 Server Connectivity

- Protocol implementation conforms to the IEC 60870-5-104 specification and parameters are fully configurable by the user
- A 4000-word register space in the module is used to exchange data between the processor and the Ethernet network

Example Application: User requires connectivity from an Allen-Bradley platform to an IEC 60870-5-104 SCADA system.

Solution: **MVI56-104S** for ControlLogix™
MVI46-104S for SLC™ 500
MVI69-104S for CompactLogix™
MVI71-104S for PLC-5™

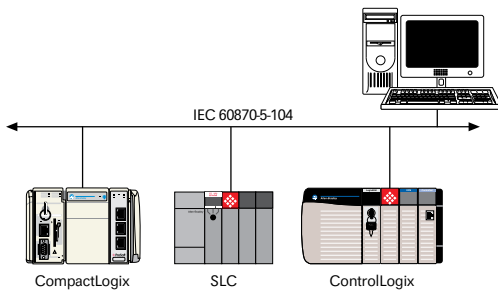

Generic Ethernet Connectivity

- Five clients and five servers to receive and/or transmit data
- Ladder programmed and configured
- 10/100 Mbits/s Ethernet-compatible interface

Example Application: User requires connectivity to (ASCII) type devices: barcode scanners, weigh scales, text displays, RFID tags, etc. using the TCP/IP protocol.

Solution: **MVI56-GEC** for ControlLogix
MVI46-GEC for SLC 500
MVI71-GEC for PLC-5
MVI69-GEC for CompactLogix

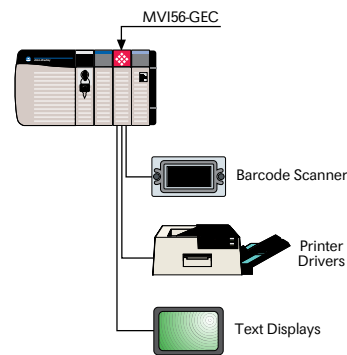

DNP 3.0 over Ethernet Connectivity

- Time stamping and Report-by-Exception
- Supports full Level 2 minimum command sets
- Ideal for substation automation, water/wastewater, and SCADA applications

Example Application: User requires DNP 3.0 connectivity from an Allen-Bradley platform to DNP 3.0-compatible device using the TCP/IP protocol.

Solution: **MVI56-DNPSNET** for ControlLogix
MVI46-DNPSNET for SLC 500
MVI71-DNPSNET for PLC-5
MVI69-DNPSNET for CompactLogix

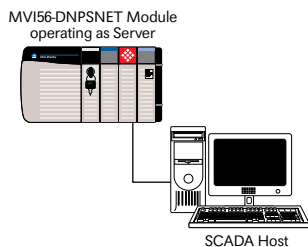

Adapters

Application Story



Just Can't Work Without It!

There are a total of 8 Atlas Copco compressors in the Shanghai plant. Six of these compressors are the ZH model, which is a centrifugal type, having an Allen-Bradley SLC™ 5/03 embedded in their control systems. The impeller design of the ZH model is state-of-the-art, with capacities starting at 3,000 cfm, in both single and multi-stage, these compressors can provide discharge pressures ranging from 25 to 400 psig.

The remaining two compressors are the Z-pack models, equipped with built-in Modbus communications. This created a problem in networking the compressors together, since the Allen-Bradley SLCs are not Modbus compatible. The System Integrator, Shanghai Yuandong Science & Technology, contacted Rockwell Automation Shanghai and ProSoft Technology®.

Shanghai Yuandong installed ProSoft's 3150 Modbus interface module into the SLCs onboard the Atlas Copco compressors, which then allowed all of the compressors to link to the HMI Host Station via the DH-485 network.

"By using ProSoft Technology's 3150-MCM module, we were able to directly connect Allen-Bradley's SLC with Atlas Copco's compressors using the Modbus protocol," said Chen Zong Liang, General Manager of Shanghai Yuandong. "With central control, it was possible to stagger the actions (start, load, unload or stop) of every compressor according to the charge situation."

"Not only did this help increase production," said Lenus Hong, Regional Manager for ProSoft Technology, "It created a cost savings in terms of electricity and maintenance costs. All of this translates into higher profits."

When asked how the ProSoft Technology module improved the plant processes, i.e. functionality, speed, convenience, or financial benefits, Liang simply replied, "It just can't work without it!"

FLEX I/O Adapters

- Supports Modbus Slave and PROFIBUS DP connectivity
- Add FLEX I/O into applications where other manufacturer networks are already in use
- Concentrate data from up to eight FLEX modules to a single node

Example Application: User requires communication interface for analog and discrete I/O directly to a non-Rockwell Automation host.

Solution: **3170-MBS** for Modbus
 3170-PDP for PROFIBUS DP

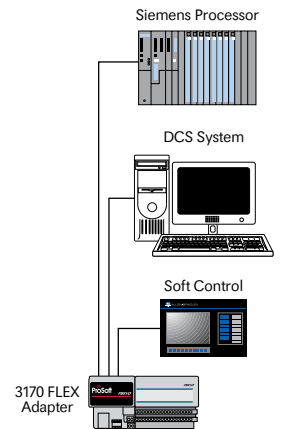

Drives/SCANport Adapters

- Simple to use, requiring only the setting of several dip-switch options
- Read/Write access to the entire parameter table in a SCANport device
- High-speed access to the operating status and control parameters

Example Application: User requires connectivity from Allen-Bradley's SCANport-compatible products, i.e. PowerFlex, A-B Variable Speed Drives (1305 Micro, 1336 Plus, Vector, Force, etc.), the SMC Dialogue Plus, and the SMP3 to alternate networks.

Solution: **1550-MBS** for Modbus
 1560-MBP for Modbus Plus
 1560-PDP for PROFIBUS DP
 1550-N2 for Johnson Control Metasys

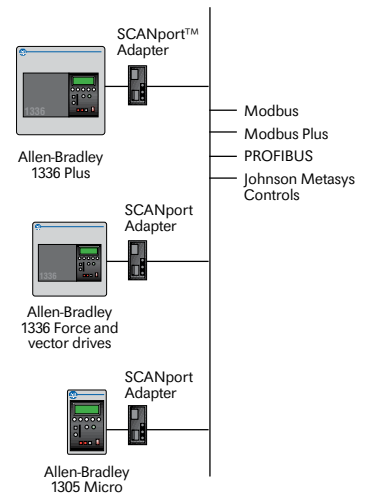

In-Rack PCs

In-Rack PC for ControlLogix™

- Provides platform for custom development of process-intensive applications (i.e. turbine control, OEM soft control, high-speed data collection, OEM C/C++ applications)
- Backplane connectivity for data with Read/Write capability
- Processing power of a PC fully integrated into the ControlLogix environment
- Software Development Kit (SDK) includes API calls to:
 - Backplane Read/Write to processor
 - User LED
 - 4 character ASCII display
 - 3 POS switch
 - Ethernet, Serial, & USB ports
 - Data storage



PC56

Example Application: User requires open platform, supporting Windows and DOS to tightly integrate their applications into the ControlLogix world.

Solution: PC56

In-Rack PC with OPC Server

- Allows OPC client software to connect directly to ControlLogix
- Multiple ControlLogix controllers may be accessed, either in the local rack or in remote racks connected via Ethernet or ControlNet
- Improved reliability and performance: No middleware between client software and ControlLogix hardware

Example Application: User needs to access data from a ControlLogix processor to an OPC client.

Solution: PC56-OPC

In-Rack PC with Data Historian

- High-speed, real-time data collection
- Store and access data locally
- Easily integrate into new or existing control systems

Example Application:

- Remote or mobile assets
- Slow or intermittently connected devices
- Electronic documentation and regulatory compliance applications
- Predictive maintenance, asset management, error analysis, and process optimization

Solution: PC56-HIST

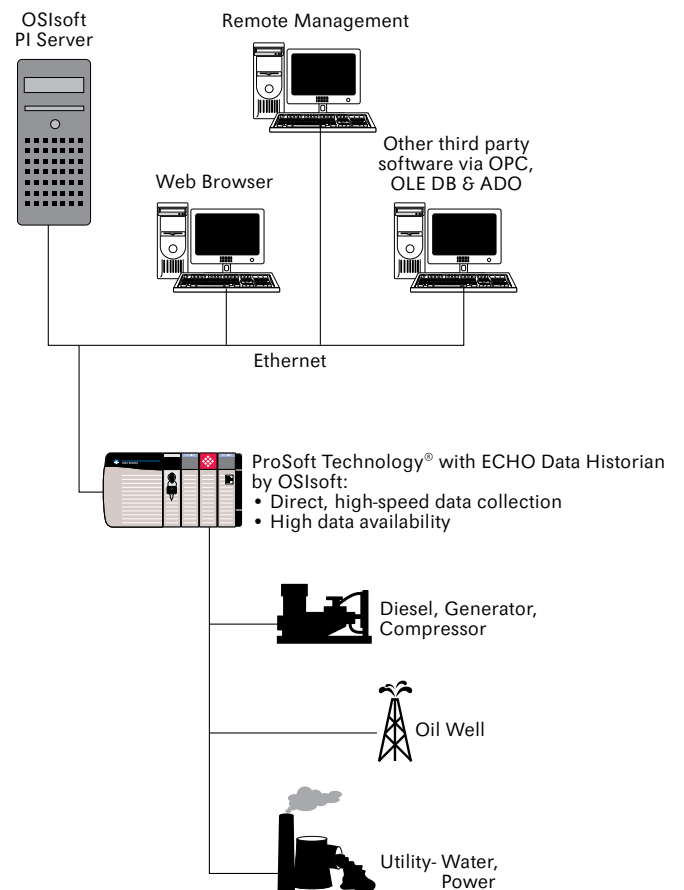



3 easy steps to find your solution

1. At the top of the chart, locate the Allen-Bradley platform you wish to use in your application.
2. In the left-hand column, locate the protocol you wish to connect to.
3. Follow the protocol across until it intersects with the platform you need. There you will find the ProSoft Technology product part number.



Platform	ControlLogix™	SLC™	PLC	CompactLogix™	FLEX™ Adapters	FLEX I/O FLEXLogix™	SCANport™ Adapters
Serial Protocol/Application							
ASCII	MVI56-GSC	MVI46-GSC	MVI71-GSC	MVI69-GSC		MVI94-GSC-E	
BASIC	MVI56-BAS						
Bosch						MVI94-BSCH	
Bristol Babcock	MVI56-BSAPS	MVI46-BSAPS					
'C' Programmable	MVI56-ADM	MVI46-ADM	MVI71-ADM	MVI69-ADM		MVI94-ADM	
Command Language Master	MVI56-CLVM						
DF1 Master/Slave	MVI56-DFCM MVI56-DFCMR	MVI46-DFCM	MVI71-DFCM	MVI69-DFCM		MVI94-DFCM	
DH-485	MVI56-DH485 MVI56-DH485R			MVI69-DH485			
DNP 3.0	MVI56-DNP	MVI46-DNP	MVI71-DNP	MVI69-DNP		MVI94-DNP	
Emerson FX		3150-EMC	3100-EMC				
Fisher ROC		3150-ROC	3100-ROC				
Foxboro/Systronics Minimote RTU		3150-SYS	3100-SYS				
Gareco Protocol	MVI56-GRCM						
Harris RTU		3150-HAR	3100-HAR				
Honeywell 7800		3150-CBM	3100-CBM				
Interbus Slave					3170-INTB		
IEC 60870-5-101 Slave	MVI56-101S	MVI46-101S	MVI71-101S	MVI69-101S			
IEC 60870-5-101 Master	MVI56-101M	MVI46-101M	MVI71-101M				
IEC 60870-5-103 Master	MVI56-103M MVI56-103MR	MVI46-103M	MVI71-103M	MVI69-103M			
Johnson Controls Metasys	MVI56-N2	MVI46-N2	MVI71-N2	MVI69-N2			1550-N2
Landis & Gyr 8979F Slave	MVI56-LNG	MVI46-LNG	3100-LNG				
Limitorque Master	MVI56-LTQ	3150-LTQ	3100-LTQ				
MDA Scientific	MVI56-MDA4 MVI56-MDA16	3150-MDA4 3150-MDA16	3100-MDA4 3100-MDA16				
MetOne PCX			3100-PCX				
Modbus Master/Slave	MVI56-MCM MVI56-MCMR	MVI46-MCM	MVI71-MCM	MVI69-MCM	3170-MBS	MVI94-MCM	1550-MBS
MTS Level Plus		3150-MTS	3100-MTS				
SM General	MVI56-SMGC						
Siemens SEAbus		3150-SEA	3100-SEA				
Siemens 3964R	MVI56-3964R	MVI46-3964R	MVI71-3964R	MVI69-3964R			
Systronics VSAT		3150-SYS	3100-SYS				
Teledyne CA Slave	MVI56-CAS		3100-CAS				
York Chiller		3150-YRK	3100-YRK				

Platform	ControlLogix™	SLC™	PLC	CompactLogix™	FLEX™ Adapters	FLEX I/O FLEXLogix™	SCANport™ Adapters
Specialty Protocols							
Modbus Plus	MVI56-MBP	MVI46-MBP	3300-MBP				1560-MBP
PROFIBUS DP Master	MVI56-PDPMVI						
PROFIBUS DP Slave	MVI56-PDPS				3170-PDP		1560-PDP
Ethernet Protocols							
Bardac device.web	MVI56-BDW	MVI46-BDW	MVI71-BDW				
'C' Programmable over Ethernet	MVI56-ADMNET	MVI46-ADMNET	MVI71-ADMNET	MVI69-ADMNET			
DNP over Ethernet	MVI56-DNPSNET	MVI46-DNPSNET	MVI71-DNPSNET	MVI69-DNPSNET			
EtherNet/IP		MVI46-DFNT	MVI71-DFNT	MVI69-DFNT			
FA Control/FL-net	MVI56-FLN			MVI69-FLN			
Generic Ethernet	MVI56-GEC	MVI46-GEC	MVI71-GEC	MVI69-GEC			
IEC 60870-5-104 Server	MVI56-104S	MVI46-104S	MVI71-104S	MVI69-104S			
Modbus TCP/IP	MVI56-MNET MVI56-MNETC MVI56-MNETR MVI56-MNETCR	MVI46-MNET MVI46-MNETC	MVI71-MNET	MVI69-MNET MVI69-MNETC			
Wireless Modules							
ProSoft Wireless Protocol	MVI56-WA-PWP	MVI46-WA-PWP		MVI69-WA-PWP			
EtherNet/IP	MVI-56-WA-EIP						
Field Instrumentation							
AGA/API Gas & Liquid Flow Computer	MVI56-AFC	MVI46-AFC	MVI71-AFC	MVI69-AFC			
HART Multi-drop	MVI56-HART	MVI46-HART	MVI71-HART	MVI69-HART			
Honeywell DE Master	MVI56-DEM	MVI46-DEM	3700-DEM				
SLC Processor							
Modbus RTU		3250-L532M					

In-rack PC w/Operating System	
Windows 2000 on 40G IDE Drive	PC56-2K-IDE
WinCE on 32M Compact Flash Module	PC56-CE
DOS on 32M Compact Flash Module	PC56-DOS
Embedded NT on 1G MicroDrive	PC56-NT
NT4.0 on 40G IDE Drive-2 module	PC56-NT-IDE
Windows XP on 1 Microdrive	PC56-XP
Windows XP on 40G IDE Drive-2 module	PC56-XP-IDE
In-rack PC w/ Data Historian	
WinXP, 56IDE25, Historian 1500 tag support	PC56-HIST-1500
WinXP, 56IDE25, Historian 3000 tag support	PC56-HIST-3000
WinXP, 56IDE25, Historian 500 tag support	PC56-HIST-500
WinXP, 56IDE25, Historian 5000 tag support	PC56-HIST-5000
Expansion Modules	
Standard KTX functionality-DH+, DH485, RIO support	PC56-KTX
PCMCIA Interface	PC56-PCM
Development Tools	
Stand-alone CD drive for software installation	PC56-CDIDE
Other	
PCI Bus Extender	PC56-PCI
OPC Servers	PC56-OPC PC56-OPC-IDE



Application Story



In-Rack PC Delivers Speed for Multihead Weigher

Triangle Machinery Company wanted to provide a control solution that was non-proprietary, enabling packaging professionals easy access to update applications when needed. Triangle Machinery required the flexibility of a Programmable Logic Controller and the processing speed of an industrial computer to have optimal performance in their Vertical Form Fill Seal Bag Machines (VFFS) application. Triangle Machinery found a solution in the Rockwell Automation ControlLogix PLC with ProSoft Technology's PC56 in-rack PC.

The industrialized PC56 computer delivers the processing power required to control the speed of the Multihead weigher. The PC56 connects directly to the backplane of the ControlLogix PLC, which gives the application an extremely high data rate exchange between the PC56 and the ControlLogix PLC. The speed of the calculations for the Multihead weigher is pivotal to the speed and efficiency of the VFFS application, as some of the larger applications have up to 24 buckets per Multihead weigher.

"The PC56s high speed communications across the ControlLogix backplane permit the tightly integrated PC-based application Triangle Machinery was looking for," said Ken Majerus, Regional Sales Manager for ProSoft Technology®. "The PC56 is the ideal solution for this type of analytical and data centric applications."

'C' Programmable Modules

- 'C' Programmable
- Two Serial Ports (ADM)
- One Ethernet port (ADMNET)
- Backplane interface to processor
- Portable code
- API Library
- Ideal for custom applications
- Ships with Digital Mars C++ compiler

Example Application: User requires a powerful structured programmed module providing an environment for creation of a custom application, ie. data manipulation, custom protocol development, complex math calculations, data storage, which cannot be accomplished easily within a PLC.

Serial Solution: **MVI56-ADM** for ControlLogix™
MVI46-ADM for SLC™ 500
MVI71-ADM for PLC-5™
MVI94-ADM for FlexLogix™ / FLEX I/O
MVI69-ADM for CompactLogix™

Ethernet Solution: **MVI56-ADMNET** for ControlLogix
MVI46-ADMNET for SLC 500
MVI71-ADMNET for PLC-5
MVI69-ADMNET for CompactLogix

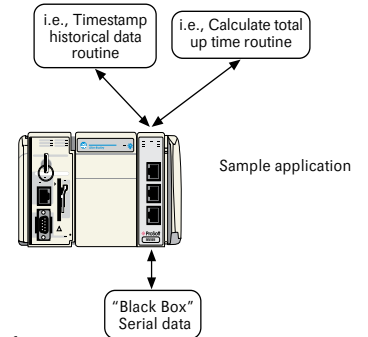

BASIC Programmable Module

- "BASIC" Programmable
- Two Serial Ports
- Backplane Interface to PLC
- Ideal for migrating existing PLC/SLC applications

Example Application: User needs to migrate a PLC or SLC "BASIC" program to ControlLogix or CompactLogix. User needs to use "BASIC" programming language for a custom application, ie. data manipulation, custom protocol development, data storage, which can not be accomplished easily within a PLC.

Solution: **MVI56-BAS for ControlLogix**

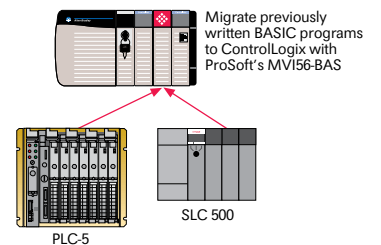

Fieldbus Automation Protocol Communication Solutions

PROFIBUS DPV1 Master for ControlLogix™

- Simple-to-use ProSoft Configuration Builder software for module setup, configuration, diagnostics and debugging
- Acyclic parameter data can be transferred with Class 1 or Class 2 DPV1, allowing online parameterization, alarming and extended diagnostics
- Cyclic Data of 1536 bytes of input and 1536 bytes of output

Solution: **MVI56-PDPMV1** for ControlLogix

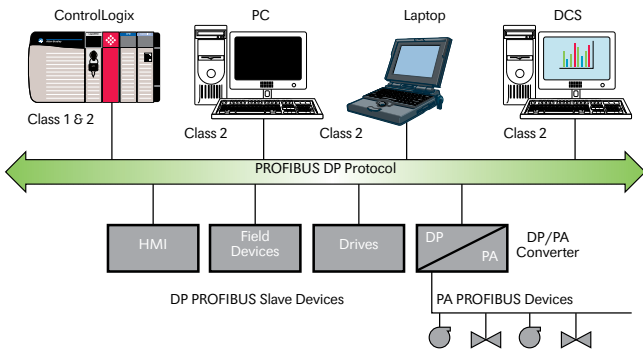

PROFIBUS DP Slave

- Allows processors to easily interface with a PROFIBUS DP Master
- Supports PROFIBUS V0 Slave implementation protocol
- 244 bytes Input and 244 bytes Output data (400 bytes maximum in and out)
- User configurable data mapping and DP port operation

Solution: **MVI56-PDPS** for ControlLogix

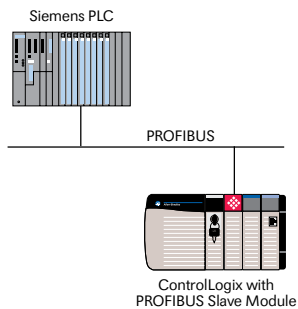

MVI56-MBP

Modbus Plus Connectivity

- Actively exchanges Global In and Out Data with Modbus Plus network
- Supports MSTR Read/Write Commands
- Backplane compatible
- True Peer-to-Peer connection with Modbus Plus network

Example Application: User requires connectivity from ControlLogix, PLCs, or SLCs directly to applications using the Modbus Plus network including foreign device data concentrator, pipelines and offshore platforms, food processing, mining, and pulp and paper.

Solution: **MVI56-MBP** for ControlLogix
MVI46-MBP for SLC™ 500
3300-MBP for PLC-5™

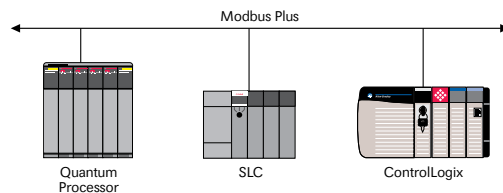

Flow & Field Application Solutions

Application Story

Flow Management for Camisea Pipeline

Facing one of the greatest pipeline challenges in Peruvian history, ISI-Solutions, the system integrators for the project, knew the application needed to rely on a cost-effective automation solution that combined the power of control and flow computers to integrate, operate and maintain pipeline control. Camisea needed an internationally recognized name brand solution with local distribution.

"We recommended the use of a Rockwell Automation platform early on as we wanted to add a highly functional backplane and flow computer," said System Integrator Fernando Dorgan. "The challenges were significant. Camisea's pipelines needed flow management control with a solution that could fit the Allen-Bradley backplane. What really made the Rockwell Automation platform functional for Camisea was ProSoft Technology's involvement in solving Camisea's flow computer needs with their in-rack AFC Module."

The pipeline SCADA system has two control centers, the primary control center will be the Lurín Main Control Center (MCC) at Lima City Gate (Lurín), and the secondary will be the Ayacucho Contingency Control Center (CCC), located in the surroundings of Ayacucho city. The latter will be used in case of a major problem at the MCC location, or interruption of communications to the MCC. Local Control Systems will control both Camisea pipelines and bring information to the SCADA Host system at the control centers to supervise those pipelines and their associated facilities: receiving, pumping, scraping, and block valves stations.

Since both pipelines run parallel and close to each other for 550 km, in many instances they will share a common local control system (i.e., a common RTU or PLC).

Local Control Systems will be implemented with ControlLogix™ and CompactLogix™ family of programmable controllers from Rockwell Automation.

In-Rack Flow Computer

- Seamless data exchange between processor and AFC module with backplane compatibility
- Detailed characterization method for AGA 8 pressure/temperature compensation
- User-friendly Windows-based system configuration
- Data archiving and event logging
- Field programmable

Example Application: User requires liquid and gas flow measurement solution with calculations based on AGA 3,7,8, and API 2540 standard measurements.

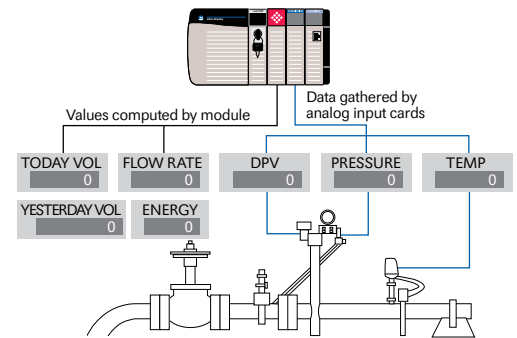

- Solution:**
- | | |
|------------------------------------|---------------|
| MVI56-AFC for ControlLogix™ | 16 Meter Runs |
| MVI46-AFC for SLC™ 500 | 8 Meter Runs |
| MVI69-AFC for CompactLogix™ | 8 Meter Runs |
| MVI71-AFC for PLC 5™ | 8 Meter Runs |

Honeywell DE Connectivity

- Direct Connection to HW DE Transmitters
- Single and Multi-variable Support
- Supports up to 16 Channels

Example Application: User requires connectivity solutions for smart field instrumentation supporting Honeywell DE networks allowing access to temperature, pressure, and multi-variable units.

- Solution:** **MVI56-DEM** for ControlLogix

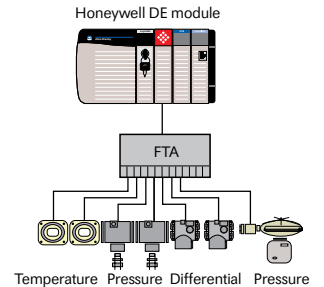

HART Multi-drop Connectivity

- Multi-drop field network
- Read/Write Data
- 4 Channels/Module
- 15 Transmitters/Channel

Example Application: User requires connectivity solutions for smart field instrumentation supporting HART multi-drop networks allowing access to temperature, pressure, and multi-variable units.

- Solution:**
- | |
|------------------------------------|
| MVI56-HART for ControlLogix |
| MVI46-HART for SLC 500 |
| MVI69-HART for CompactLogix |
| MVI71-HART for PLC 5 |

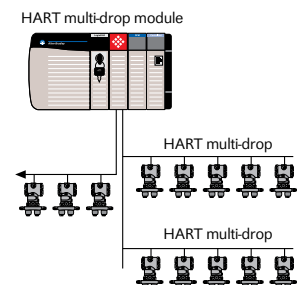

In-Rack Wireless Communication Solutions



High-Speed Wireless Connectivity

- ProSoft Wireless Protocol (PWP) offers versatility where a mix of control devices requires cooperation with each other
- Supports one-to-one or one-to-many wireless connection scenarios
- 2.4 GHz, Direct Sequence Spread Spectrum radio
- Output power: 32 mW (15 dBm), up to 500 mW (27 dBm)
- Outdoor range up to 20 miles (according to country regulation) with optional external amplifier
- 64/128 Encryption security

Example Application: User requires sharing of information across remote applications regardless of device or network type, often at high speed.

Solution: **MVI56-WA-PWP** for ControlLogix
MVI46-WA-PWP for SLC™ 500
MVI69-WA-PWP for CompactLogix™

ProSoft Tested



Proven Connectivity Solutions with ProSoft Tested

In order to ensure confidence and success with the use of our products, ProSoft Technology® has implemented the ProSoft Tested Program. Upon request, we will conduct extensive testing on any device to ensure compatibility with ProSoft Technology products. This free testing includes:

- Proven connections documentation
- Simulation of field applications
- Detailed test reports
- All protocol commands tested
- All accessory requirements listed
- Various configurations tested
- All reports available on the website

Know with confidence that your application will work. The listing below is a partial list of products that are known to be ProSoft Technology compatible. For a complete list, go to www.prosoft-technology.com. If you would like your application tested, contact ProSoft Technology and ask for the ProSoft Tested Program. We'll arrange for your product to be tested at no charge to you.

- Bar Code Scanners
- Chart Recorders
- Level Interfaces
- Loop Controllers
- PLC Manufacturers
- Temperature Controllers
- Power Devices
- Drives
- Flow Devices
- Valves

Specialty Protocol Interfaces

Customize It

Custom Development and Engineering Services

If you are looking for an off-the-shelf interface for your particular application, ProSoft Technology® has your answer. Our team of developers can create customer-defined solutions that fit your needs. To discuss how ProSoft Technology can resolve your connectivity challenges, please contact our Development Department at +1.661.716.5100 or email: prosoft@prosoft-technology.com.

The following pages contain various examples of custom engineering for our customers.

Packaging

Bosch Interface for Robert Bosch Packaging Machinery

- Continuous polling of Bosch slave devices
- Up to 100 user-defined commands supported

Example Application: User requires a communication interface with Bosch SVB/SVK compatible slave devices and the FLEX I/O platform.

Solution: **MVI94-BSCH** for FLEX I/O

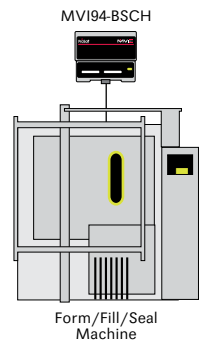

Building Maintenance Industry

Johnson Controls Metasys N2 Slave Connectivity

- Applications benefiting from the N2 module are prevalent in commercial building and energy management projects

Example Application: User requires an interface between Rockwell Automation processors and the Johnson Controls N2 network

Solution: **MVI46-N2** for SLC™ 500
MVI56-N2 for ControlLogix™
MVI69-N2 for CompactLogix™
MVI71-N2 for PLC-5™

YORK Chiller Master Connectivity

- Provides backplane communication between an Allen-Bradley processor and YORK (Johnson Controls) Chillers

Example Application: User requires a gateway between Rockwell Automation processors and YORK air and water-cooled Chillers.

Solution: **3150-YRK** for SLC 500
3100-YRK for PLC-5

Siemens SEABus Master Connectivity

- Designed to communicate directly with multiple Siemens Power Meter devices

Example Application: User requires the collection of data from Siemens 4300, 4700 and Static Trip III devices.

Solution: **3150-SEA** for SLC 500
3100-SEA for PLC-5

Power Industry

Harris 5000/5500/6000 RTU Slave Connectivity

- Applications are found mainly in the power industry: foreign device data concentrators, power equipment monitoring and dam operation

Example Application: User requires an interface between Rockwell Automation processors and Harris M9000 Host-based system.

Solution: **3100-HAR** for PLC-5™
3150-HAR for SLC™ 500

Landis & Gyr Telegyr 8979F Connectivity

- SCADA systems supporting this application are found in the power utility industry

Example Application: User requires a gateway between Telegyr 8979 Rev. F version of the protocol and the Allen-Bradley backplane.

Solution: **MVI46-LNG** for SLC 500
MVI56-LNG for ControlLogix™
3100-LNG for PLC-5

Water Industry

MetOne PCX Water Master Connectivity

Example Application: User requires an interface between a PLC-5 and MetOne Particle Counting Sensors.

Solution: **3100-PCX** for PLC-5

MTS Level Plus Interface Module

- Widely used in water applications to measure level, interface, and temperature simultaneously
- Support for up to 64 MTS Level Plus sensors

Example Application: User requires an interface between Rockwell Automation processors and MTS Level Plus Sensors.

Solution: **3150-MTS** for SLC 500
3100-MTS for PLC-5

ASCII Communications

Honeywell 7800 Series Master Connectivity

- Supports up to 32 Honeywell nodes per serial port
- Two fully configurable serial ports, each capable of supporting the CBM Master functionality using the ASCII mode of communications

Example Application: User requires an interface between Rockwell Automation processors and Honeywell 7800 Series Burner Management hardware devices.

Solution: **3100-CBM** for PLC-5
3150-CBM for SLC 500

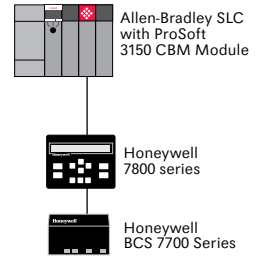

Command Language Master Connectivity for SICK Barcode

- Compatible devices include SICK® Barcode Scanners supporting Command Language Protocol

Example Application: User requires a communication interface between the ControlLogix processor and SICK barcode scanner devices.

Solution: **MVI56-CLVM** for ControlLogix

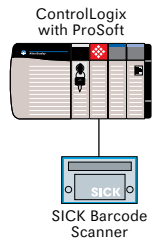

Baggage Handling

Siemens 3964R Connectivity

- The solution can be used in a local I/O rack (SLC), or in a local/remote rack for the ControlLogix or PLC5
- The 3964R protocol was designed by Siemens for bi-directional data communication through a point-to-point connection. It is a peer-to-peer protocol with read and write access

Example Application: User requires point-to-point communication between a Rockwell Automation controller and a partner with 3964R (with or without RK512) communication capability.

Solution: **MVI46-3964R** for SLC 500
MVI56-3964R for ControlLogix
MVI71-3964R for PLC-5

Application Story



Water Filtering Made Easy

The City of Bismarck, North Dakota in the northern part of the United States, drafted a plan to upgrade their water plant filter beds. Brad Wright and Bruce Dralle of the City of Bismarck Engineering Department and Charlie Jaszkwiaik, Plant Superintendent of the City of Bismarck Water Treatment Plant contacted Ferguson/Thrall, a distributor for Limitorque valves. Together they designed a plan which included the use of Limitorque's Accutronix MX in a network system using Allen-Bradley's PLC-5 with ProSoft Technology's 3100-LTQ Master Module. These modules are single slot solutions, which communicate directly over the backplane with the Allen-Bradley processors and support the Limitorque redundant loop network mode of communications as well as a single multi-drop network.

The completed project allows 26 million gallons of water per day to be filtered with plans to increase that capacity to 40 million gallons per day.

Petro-Chemical Industries

MDA Scientific (Honeywell/Zellweger) Gas Analyzer Module

- Uses standard A-B program software
- Simple data table configuration

Example Application: User requires an interface as a host with MCI Scientific CM4 or System 16 gas monitoring hardware.

Solution: **3150-MDA** for SLC™ 500
MVI56-MDA4 for ControlLogix™
MVI56-MDA16 for ControlLogix
3100-MDA for PLC-5™

Teledyne CA Slave Communication Module

- The Teledyne Brown Engineering Control Applications (CA) VECTOR SCADA system is an eight-bit protocol that can be used in a point-to-point or a multi-drop configuration
- Typically used as a SCADA slave in remote controller racks for the oil and gas or wastewater industries

Example Application: User requires a gateway between the Teledyne CA network and the Allen-Bradley backplane.

Solution: **MVI56-CAS** for ControlLogix
3100-CAS for PLC-5

Drives

Bardac drive.web Connectivity

- Four independent clients interface with up to four drives simultaneously
- 100 commands supported per client permitting control and monitoring of many values and parameters from several drives

Example Application: User requires communication between a Rockwell Automation processor and Bardac drive.web compatible drives using the UDP protocol on a network.

Solution: **MVI46-BDW** for SLC 500
MVI56-BDW for ControlLogix
MVI71-BDW for PLC-5

Emerson FX Drives Connectivity

- Allows processor to act as host with up to 8 drives (4 per port)
- Applicable industries include packaging, automated assembly, automotive manufacturing, converting, material handling and food processing

Example Application: User requires communication between Allen-Bradley compatible processors and up to eight Emerson FX series drives.

Solution: **3150-EMC** for SLC 500
3100-EMC for PLC-5

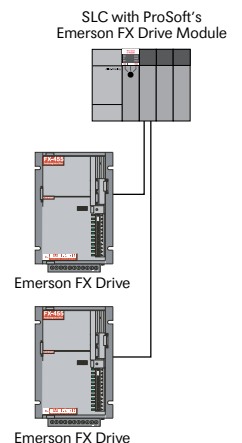

Specialty Protocol Interfaces

Foxboro/Systronics Minimote RTU

Slave Connectivity

- Acts and functions as a Systronic RTU allowing the user to easily configure both ports to be Slaves to a Foxboro/Systronics Host
- Supports Report-by-Exception capabilities associated with VSAT (satellite) implementations of the protocol

Example Application: User requires an interface between Rockwell Automation processors and the Foxboro/Systronics Minimote RTU Slave.

Solution: **3100-SYS** for PLC-5™
 3150-SYS for SLC™ 500

FA Control Network Connectivity

- Applications include multi-vendor communications of programmable controllers, NC controllers, robotic and other motion control systems
- FL-net is a masterless system and is specified for a 50 ms cycle time for 32 nodes. Up to 254 nodes can be addressed

Example Application: User requires an interface between the ControlLogix™ platform and the FA Control Network, FL-net version 2.00 defined by the Japan Electrical Manufacturers Association.

Solution: **MVI56-FLN** for ControlLogix
 MVI69-FLN for CompactLogix™

Bristol Babcock Serial Slave Connectivity

- Supports the Bristol Babcock Synchronous/Asynchronous communication protocol for a proprietary network that has a tree structured topology
- Each link in the polled network is capable of supporting a different poll rate

Example Application: User requires a gateway between the Bristol Babcock network and Rockwell Automation processors.

Solution: **MVI46-BSAPS** for SLC 500
 MVI56-BSAPS for ControlLogix

Fisher ROC Connectivity

- Contains opcodes 180 and 181 of the ROC protocol allowing the user to read and write data that cannot be accessed via Modbus

Example Application: User requires a communication interface with the ROC proprietary protocol for Fisher-Rosemount RTU and Rockwell Automation processors.

Solution: **3100-ROC** for PLC-5
 3150-ROC for SLC 500

Flow

Limatorque Master Connectivity

- Implements Limatorque's port A/B polling scheme using both ports
- Supports MX/DDC Modbus, UEC-3-DDC Modbus, DDC-100M I/O module, DDC-100M field unit, Valvcon IVO (unit in multi-drop mode only)

Example Application: User requires the implementation of a redundant loop network or a multi-drop network with up to 150 Limatorque valve actuators.

Solution: **3150-LTQ** for SLC 500
 MVI56-LTQ for ControlLogix
 3100-LTQ for PLC-5

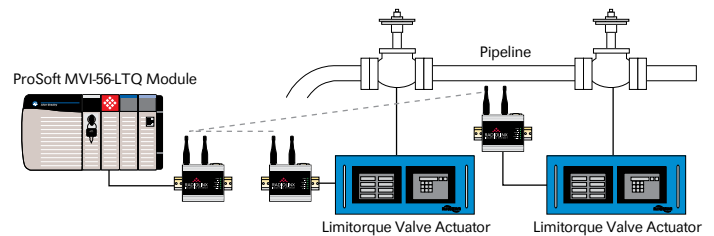

Where Automation Connects.



About ProSoft Technology®

ProSoft Technology, Inc. specializes in the development of communication solutions compatible with the large automation suppliers' controllers such as Rockwell Automation and Schneider Electric. The primary focus is to provide connectivity solutions that link dissimilar automation products. ProSoft Technology's offerings consist of four primary product families: Protocol and network connectivity modules known as **inRAX®** for Rockwell Automation and **ProTalk®** for Schneider Electric, stand-alone gateways, protocol interfaces, and wireless gateways known as **ProLinx®**, and industrial serial and Ethernet wireless modules known as **RadioLinx®**.

Over the last 15 years, ProSoft Technology's product lines have grown to over 400 communication modules supporting more than 60 different protocols. ProSoft Technology provides field-proven connectivity and communication solutions that bridge between various automation products as seamlessly as if they were all from the same supplier. These connectivity options enable controller platforms to provide solutions in areas such as computing gas flow calculations and SCADA telemetry applications. These solutions also enable interfacing to motor controls, drives and other devices in industries such as water/wastewater, power generation, oil & gas, machinery, packaging, and production.

ProSoft Technology is committed to providing localized sales and support to customers worldwide. Sales, product engineering and support services are provided internationally by over 500 distributors in 52 countries and served by Regional Area Offices in North America, Latin America, Europe and Asia Pacific.

Asia Pacific

+603.7724.2080

asiapc@prosoft-technology.com

Brasil

+55.11.5084.5178

brasil@prosoft-technology.com

Europe

+33 (0)5.34.36.87.20

europe@prosoft-technology.com

India

+91.11.2224.2655

india@prosoft-technology.com

Latin America

+1 281.298.9109

latinam@prosoft-technology.com

North America

+1 661.716.5100

Fax: +1 661.716.5101

info@prosoft-technology.com

inRAX®

ProLinx®

RADIOLINX®

ProTalk

ProSoft®
TECHNOLOGY
www.prosoft-technology.com